

> Contents

Correct Operation	4	ATEX	18
Intended Use		ATEX	
Maximum Capacity		Classification [Zone 2]	
Inspection Prior to Initial Operation		Classification [Zone 1]	
Inspection Before Starting Work		Spark Formation	
Temperature Range		Static Electricity	
Notes for Correct Operation		Inspection, Maintenance & Repair	
Warning			
Fall Protection Applications	7	Assembly Instructions	20
Use as a Fall Protection Anchor		Dimensions	28
Additional Notes for Correct Operation		Quality & Safety	32
Warning		Regulations, Standards & Directives	
IRATA		Accreditations	
		Conformité Européenne [CE]	
Inspection & Maintenance	17	The Queen's Award for Enterprise	
Regular Inspections		Testing	
Maintenance & Repair		Language	
Storage & Transportation		Product IPR	
		Product Labelling	34
		Inspection Record	35



Lightweight. Portable. **Safe.**

Please read the following instructions and guidance notes carefully, before using or operating the system.

They contain important information about how to handle and use the system in a safe and efficient way, avoiding danger, reducing repair costs and downtime, and increasing the reliability and lifespan of the system.

They apply for:

- Operation, including preparation, troubleshooting during operation and cleaning
- Maintenance, inspection and repair
- Transportation

It is the responsibility of the end user to adhere to the Health & Safety and accident prevention standards and legislation valid in their respective countries and any regions in which the system is being used. It is also incumbent on the user or competent person to ensure that anyone working with the equipment has the necessary medical and physical capabilities. A rescue plan also needs to be in place in the event of an emergency that could occur during the work. This document should form part of the overriding Risk Assessment and Method Statement required for each lift.



Intended Use

This product is designed, tested and intended to be used for the lifting of goods, the lifting of personnel or for providing a safety anchor for the prevention of falls as part of a personal fall protection system. (PFAS). The use of our products for these multiple applications is consistent with the products design, notwithstanding pre-user inspections and mandatory inspections by a competent or qualified person, determined by local regulations.

Maximum Capacity

Lifting of Goods: Each product will be marked with a Working Load Limit (WLL). The WLL is specifically intended as a maximum limit for the lifting of goods, materials and equipment and includes safety factors. When using modular gantries, due to the interchangeability of A frames and beams to suit the customers need, the lowest rated element of the gantry always takes precedent. A-frames are independently marked with a WLL for safety.

Lifting of Personnel: For the lifting of personnel REID Lifting will reduce the WLL by half, thereby increasing the safety factor of the product. As for lifting goods, materials and equipment, the lowest rated element of the Gantry always takes precedent. Associated equipment used for lifting personnel must be rated accordingly. It is the employers' responsibility to ensure this is the case. For example, a winch must be personnel rated and where necessary, meet applicable standards and regulations for the country of use.

Fall Protection Anchor: In most cases (subject to labelling and instructions for use for specific products confirming this) REID lifting products are tested and meet the requirements of fall protection standards and regulations, including EN795:2012, CEN TS 16415:2013 and IRATA ICOP as referenced in our Instructions for Use. The WLL on the beam or A-frame is of no relevance to fall protection standards and requirements and the user should refer to the specific sections of the instructions for use, for detailed information. For example; EN795 requires that anchors that form part of a personal fall protection system are capable of withstanding a minimum 12kN static load for a single user and a further 1kN for each additional user. IRATA requires a 15kN static load. Additionally, fall protection systems are required to pass a series of dynamic performance tests. REID Lifting products will, where applicable be marked with the rating for fall protection. Safety factors will be higher than those for lifting and forces will be limited by the use of personal fall protection equipment, including load limiting devices such as shock absorbers or self-retracting lifelines that reduce impact forces, typically to a maximum of 6kN per user as required by law.

Note: some jurisdictions may not allow the same equipment to be used for lifting of materials and as a component of a PFAS. Some employers may also prefer to keep such equipment distinctly separate. If this is the case, we would recommend that the equipment is labelled accordingly. Check your local regulations before putting equipment to use and designate accordingly.

It is expected that all users of this product have the necessary medical and physical capabilities, are fully trained and deemed competent in its safe assembly and use. We would remind users of the requirement to ensure that work is properly planned, risk assessments carried out and as required, method statements for carrying out work provided.

Where required the owner/user of the equipment should ensure that a qualified person has been consulted in respect of the need for structural validation, for example (but not limited to); calculating imposed loads for the safety of ground, floor or roof structures during lifting operations.

This product has different ratings depending upon the application as detailed in the table below:

Model	PGR520	PGR523, PGRM20, PGRM23	PGR540, PGRM40, PGRT20, PGRT23, PGRT40
Application	WLL (kg)	WLL (kg)	WLL (kg)
Personnel positioning limit	250	200	125
Goods	500	400	250

Model	PGR1T520, PGR1T530, PGR1T540, PGR1TM20, PGR1TM30, PGR1TM40, PGR1TT20, PGR1TT30, PGR1TT40
Application	WLL (kg)
Personnel positioning limit	500
Goods	1000

For fall protection applications see page 7.

Inspection Prior to Initial Operation

This product must be inspected prior to initial operation by a competent person to ensure that the structure is safe and that it has not been damaged by incorrect assembly, transport or storage.

Inspection Before Starting Work

Before starting work, the assembly of the product and all load-bearing components should be checked for visual defects. This includes checking the integrity of all profiles for denting, making sure there is no wear or elongation on the bolt holes and ensuring that the trolley moves freely along the beam.

Temperature Range

This product can be operated in ambient dry temperatures between -20°C and $+55^{\circ}\text{C}$ (-4°F and 131°F). Consult your supplier in case of extreme working conditions.

Notes for Correct Operation

- For optimum safety, we recommend single person assembly to avoid conflicting actions.
- Assemble only as instructed (ensure all bolts are present and fitted correctly as per instructions).
- Suitable, appropriately rated winches and connection plates must be used for all applications.
- The product should be set up at a safe distance from the hazard or lift area, before moving the structure into place.
- The supporting ground/structure where the gantry is to be used must be stable and capable of withstanding the maximum expected load applied during use.
- We recommend that appropriate PPE is worn when using the equipment.
- The beam must be horizontal prior to any lift and A-Frames vertical and parallel to each other.
- Do not use the product if the trolley does not run freely along the beam. (For certain applications, such as when the system is being used as a restraint point, the trolleys can be locked into position).



- Attach the hoist to the lifting point on the trolley only, making sure it is attached in a way that does not expose the user to danger by the hoist, chain or load.
- Only raise and lower loads when castor brakes are engaged.
- Do not allow the load to swing.
- To avoid side pull, lowering and lifting should only be carried out when the load chain forms a straight and vertical line between the load and lifting attachment point on the trolley. If a vertical lift is not possible you must ensure that the load is within the footprint of the Gantry A-Frames (refer to figure A).



- We recommend the use of load-sensing or overload protection devices on all lifts.

- The product should not be moved under load except when a competent person or authority has approved a risk assessment and method statement.
- The risk assessment and method statement must take into account any factors that might apply additional loading to the system during lifting operations.
- Take care when transporting and storing the system to avoid damage.
- To ensure stability of the structure, the operating span of the beam must be equal to or greater than the distance between the castors on the A-Frame.
- The equipment should not be used outside of its limitations, or for any purpose other than that for which it is intended.
- Do not lift or transport loads while personnel are in the danger zone.
- Do not allow personnel to pass under a suspended load.
- Never leave a suspended load unattended.
- Do not start moving the load along the beam until you have checked that it has been attached correctly.
- When moving a loaded trolley along the beam, move the load steadily and in a controlled manner and avoid sudden movements.

- Don't allow the load to hit the system frame.
- When winching, only use one winch with each sheave and make sure they never cross paths with each other.
- Be aware of any adverse weather conditions such as strong or gusty winds which could impose additional horizontal loads and affect the stability of the structure. Stop using if weather is impacting on lifting, and either disassemble the gantry or tie it to a rigid structure to ensure it can't overturn.
- Be aware of hazards when setting up/folding down, such as trapping fingers in rotating parts.

Note: The Rapide Tall Systems are fitted with trolley stops on the beam (see below). This is a safety feature and must always be in place before use. If beam length adjustment is required, stops must be repositioned accordingly.





Use as a Fall Protection Anchor

This section must not be read in isolation from all other sections of this manual. Read the whole manual before using this product.

Fall arrest: This product is tested and conforms to the requirements of EN795:2012 Personal Fall Protection Equipment – Anchor Devices for single or multiple users and CEN TS 16415:2013 subject to the configuration of the product being used. When being used for fall arrest, the operator must use a body harness and a shock absorber that complies with the relevant national standards and regulations and that limits the maximum allowed force (MAF) to 6kN.

Users may be attached to the system via a travelling trolley (which may also be locked in place) or via a fall protection device mounted to the side trap plate of the A-frame, which is subsequently deviated through a pulley and sheave carrier. Only one person should be attached to each trolley in accordance with the notified working load limit (WLL).

Each personnel lift must be properly planned, and all weights clearly known along with a clear understanding of the WLL and constraints of all personal fall arrest system components.

The capabilities stated in the table below apply to standard range systems only. If unsure about your system consult serial labels, information filled in on page 35 or consult your supplier.

Custom versions of the system are available tailored to specific lifting needs. These versions are designated with a 'C' at the end the product number on the serial label attached to each A-frame and beam.

Model	PGRS20	PGRS23, PGRM20, PGRM23	PGRS40, PGRM40, PGRT20, PGRT23, PGRT40
Application	Capacity (Persons)	Capacity (Persons)	Capacity (Persons)
Fall Arrest*	3	2	1

Model	PGR1TS20, PGR1TS30, PGR1TS40, PGR1TM20, PGR1TM30, PGR1TM40, PGR1TT20, PGR1TT30, PGR1TT40
Application	Capacity (Persons)
Fall Arrest*	3

* Only Applicable to the product being used in accordance with PD CEN/TS 16415:2013 recommendations for anchor devices for use by more than one person. When being used in accordance with EN795:2012, the structure shall be limited to a maximum of one user in fall arrest.

Additional Notes for Correct Operation

- ▶ The anchorage must always be above the users head to prevent dangerous free falls.
- ▶ Always carry out pre-use checks before using this equipment. It is advised to use a buddy system and inspection must be by a competent person.

- ▶ The fall arrest device must only be attached to the lifting point on the trolley or the designated location on the cheek plate or upright (see product images and set up instructions).
- ▶ Only use the product for fall arrest applications when the castor brakes are engaged.
- ▶ To ensure stability of the structure, the operating span of the beam must be equal to or greater than the distance between the castors on the A-Frames.
- ▶ Always consider the potential effects of sharp edges, chemical reagents, electrical conductivity, cutting, abrasion, climatic exposure on all components of the fall protection system, and the effect of offset forces as a result of pendulum falls.
- ▶ Ensure the structure on which the product is mounted is horizontal. If necessary, adjust the products feet to achieve a level operating structure.
- ▶ If the product has been subjected to a fall arrest or impact force it must be immediately removed from service.
- ▶ The substrate of the structure on which the product is placed must be able to sustain the loads specified for the device in all orientations permitted, including a safety factor of at least 2.
- ▶ Never exceed the number of allowable users.



- Never walk away from the footprint of the product or move outside designated safe zones whilst connected to it where there is a risk of a fall (refer to figure B). Ensure that the operating area is within the footprint of the system before beginning work.

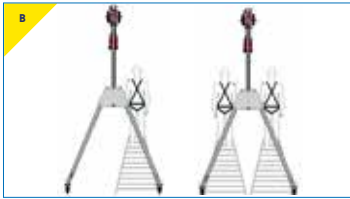

- When using the product as a fall arrest anchor ensure there is adequate fall clearance when working at height (refer to figure C) A competent person should calculate this taking into account all of the components of the personal fall arrest system and allowing a safety margin.



- Never adjust the product whilst a person is attached to it.

- Only use designated anchor points for the attachment of fall protection devices.
- Ensure that any fall protection system components being used are compatible and meet the requirements of applicable standards.
- When using this equipment ensure that there is a rescue plan prior to starting work and ensure that users are trained in the correct execution of the plan and have all necessary rescue equipment to hand.
- Where required by regulation, each installation must be approved by a qualified person.
- Always wear appropriate PPE when installing, setting up, dismantling and using this equipment.
- Misuse of this product could result in serious injury or death.

Warnings

- For fall protection applications the maximum user weight is 150kg or the weight allowed by the lowest rated piece of equipment in the fall arrest system.
- Ensure that you have read and understood the maximum force tables for each anchor point.
- This equipment must only be assembled, installed and used by persons who have been

trained in its correct application and use.

- When using for fall protection, only use one fall arrest device with each pulley/sheave and make sure that working procedures prevent individual lifelines from crossing and becoming tangled.
- When using the product in conjunction with another manufacturer's fall protection products, ensure that you have read the instructions for use of those products to ensure their suitability and any restrictions for use. Only use approved brackets for the connection of winches and self-retracting lifelines.
- It is essential for safety that the product is withdrawn from use immediately and not be used again until confirmed in writing by a competent person should;
 1. Any doubt arises about its condition for safe use or;
 2. It has been used to arrest a fall
 3. It has been used for any other purpose, other than as a component of a personal fall protection system.

IRATA [International Rope Access Trade Association]

This product is suitable for rope access and has been tested to 15kN static load as per test requirements of IRATA International Code of Practice (ICOP).

Fall Protection/Confined Space Set Up | 1 User

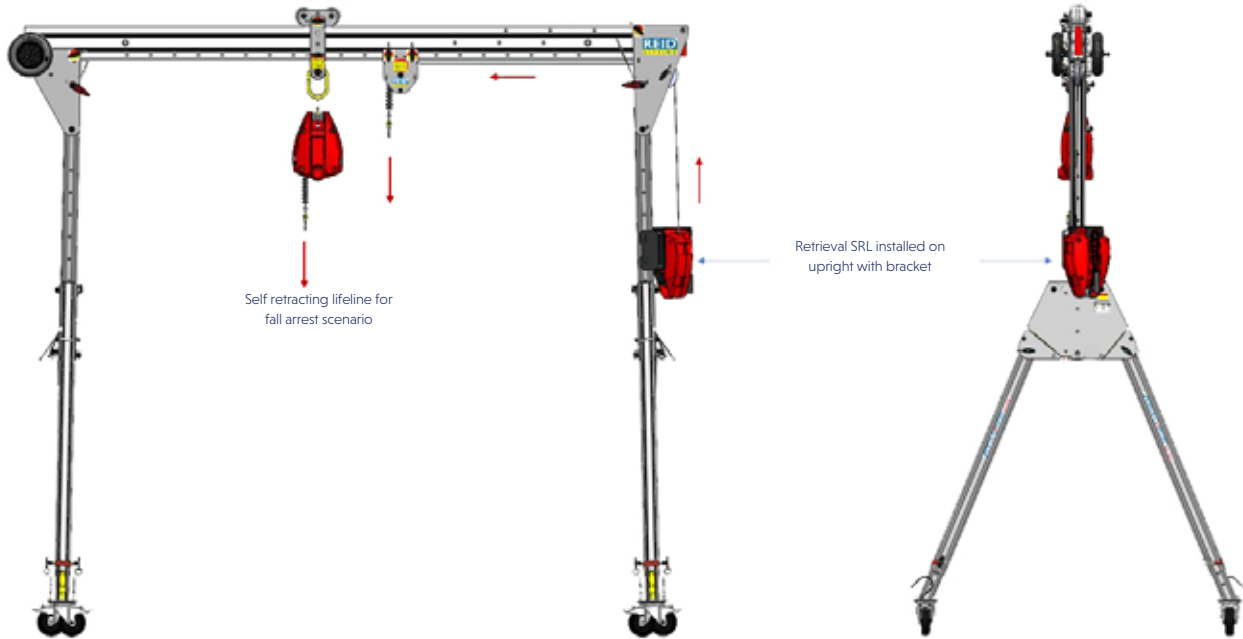

*Set up is indicative - Various winch brackets available.
Masterlink or Close Coupled trolley options available.



Fall Protection/Confined Space Set Up | 1 User

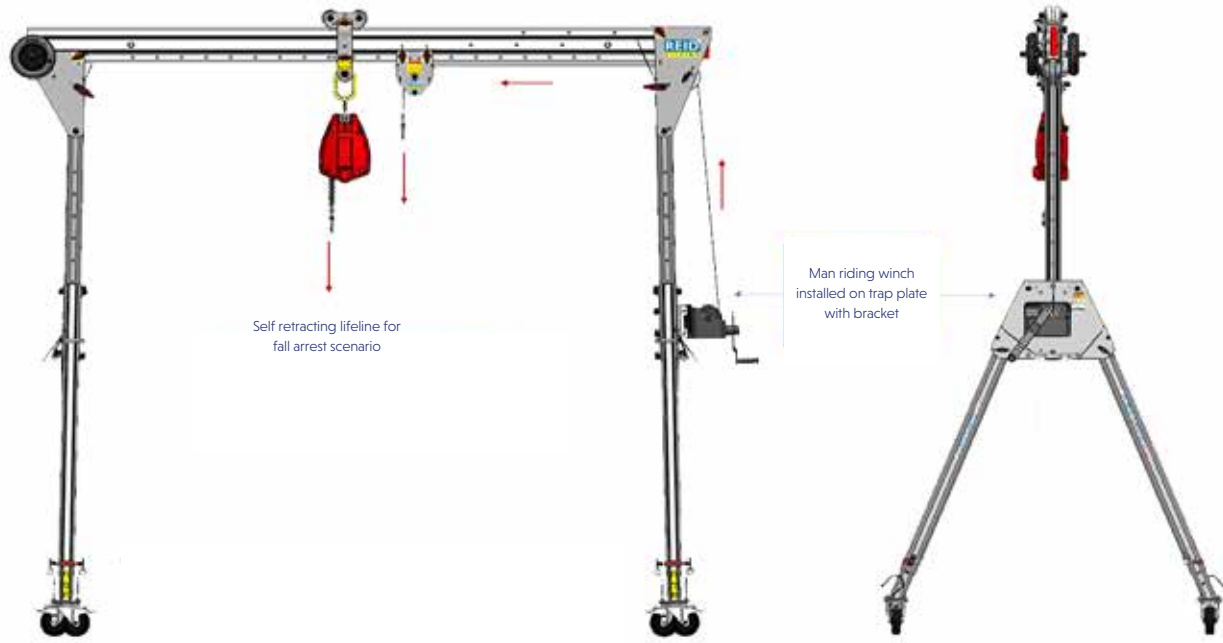

*Set up is indicative - Various winch brackets available.
Masterlink or Close Coupled trolley options available.

Fall Protection/Confined Space Set Up | 2 Users [PGR1000 Only]

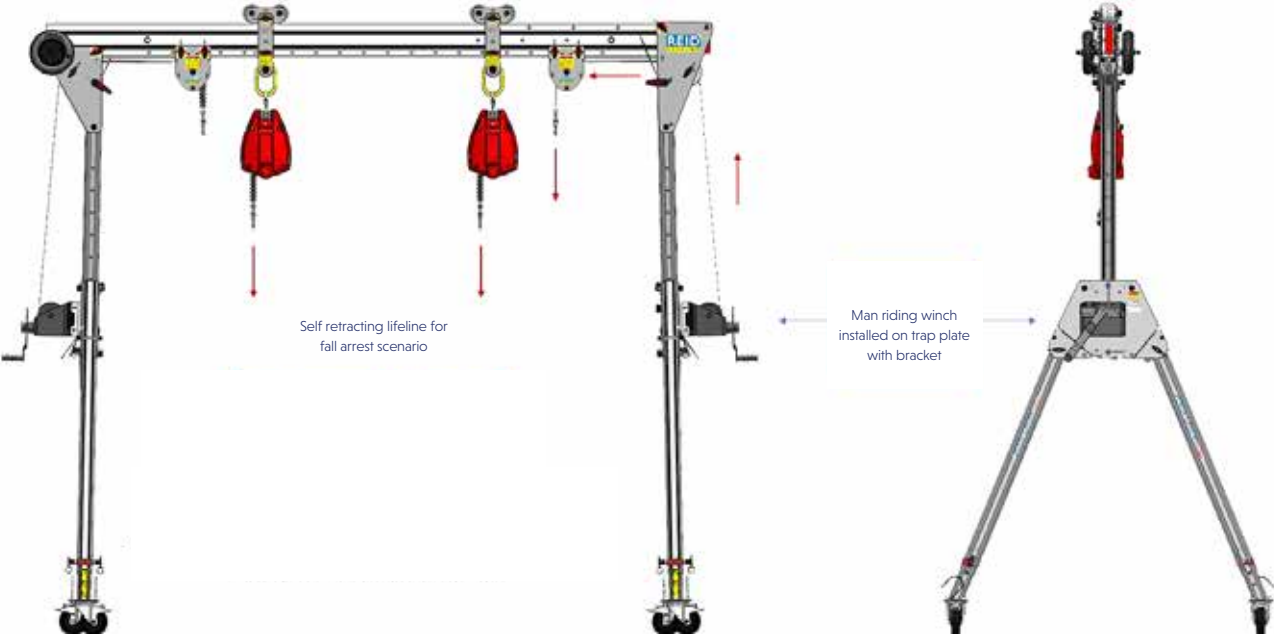

*Set up is indicative - Various winch brackets available.
Masterlink or Close Coupled trolley options available.



Fall Protection Set Up | 2 Users [PGR1000 Only]

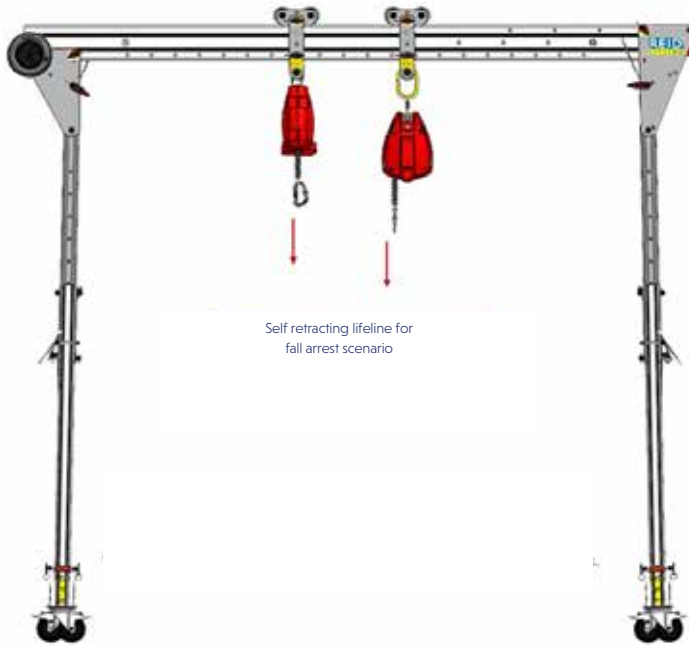

Self retracting lifeline for
fall arrest scenario



*Set up is indicative - Various winch brackets available.
Masterlink or Close Coupled trolley options available.

PORTAGANTRY RAPIDE 500kg | **Fall Protection Anchor Ratings**

Winch or SRL position on upright.

F = Maximum Rated Force

* Set up is indicative

PGR 500				
Product Code	Anchor Point 'A'	Anchor Point 'B'	Anchor Point 'C'	Max No. Users
PGRS20J	15 kN	15 kN	12 kN	2
PGRS23J	15 kN	15 kN	12 kN	2
PGRS40J	15 kN	15 kN	12 kN	1
PGRM20J	15 kN	15 kN	12 kN	2
PGRM23J	15 kN	15 kN	12 kN	2
PGRM40J	15 kN	15 kN	12 kN	1
PGRT20J	15 kN	15 kN	12 kN	1
PGRT23J	15 kN	15 kN	12 kN	1
PGRT40J	15 kN	15 kN	12 kN	1

All trolleys and sheave carriers are rated for one user.



PORTAGANTRY **RAPIDE** 500kg | Fall Protection Anchor Ratings

Winch or SRL
position
on trap plate

F = Maximum Rated Force

* Set up is indicative

PGR 500				
Product Code	Anchor Point 'A'	Anchor Point 'B'	Anchor Point 'C'	Max No. Users
PGRS20J	15 kN	15 kN	12 kN	2
PGRS23J	15 kN	15 kN	12 kN	2
PGRS40J	15 kN	15 kN	12 kN	1
PGRM20J	15 kN	15 kN	12 kN	2
PGRM23J	15 kN	15 kN	12 kN	2
PGRM40J	15 kN	15 kN	12 kN	1
PGRT20J	15 kN	15 kN	12 kN	1
PGRT23J	15 kN	15 kN	12 kN	1
PGRT40J	15 kN	15 kN	12 kN	1

All trolleys and sheave carriers are rated for one user.

PORTAGANTRY RAPIDE 1000kg | **Fall Protection Anchor Ratings**

Winch or SRL position
on upright.

F = Maximum Rated Force

* Set up is indicative

PGR 1000				
Product Code	Anchor Point 'A'	Anchor Point 'B'	Anchor Point 'C'	Max No. Users
PGR1TS20J	15 kN	15 kN	12 kN	3
PGR1TS30J	15 kN	15 kN	12 kN	3
PGR1TS40J	15 kN	15 kN	12 kN	3
PGR1TM20J	15 kN	15 kN	12 kN	3
PGR1TM30J	15 kN	15 kN	12 kN	3
PGR1TM40J	15 kN	15 kN	12 kN	3
PGR1TT20J	15 kN	15 kN	12 kN	3
PGR1TT30J	15 kN	15 kN	12 kN	3
PGR1TT40J	15 kN	15 kN	12 kN	3

All trollies and sheave carriers are rated for one user.



PORTAGANTRY RAPIDE 1000kg | Fall Protection Anchor Ratings

Winch or SRL
position
on trap plate

F = Maximum Rated Force

* Set up is indicative

PGR 1000				
Product Code	Anchor Point 'A'	Anchor Point 'B'	Anchor Point 'C'	Max No. Users
PGR1TS20J	15 kN	15 kN	15 kN	3
PGR1TS30J	15 kN	15 kN	15 kN	3
PGR1TS40J	15 kN	15 kN	15 kN	3
PGR1TM20J	15 kN	15 kN	15 kN	3
PGR1TM30J	15 kN	15 kN	15 kN	3
PGR1TM40J	15 kN	15 kN	15 kN	3
PGR1TT20J	15 kN	15 kN	15 kN	3
PGR1TT30J	15 kN	15 kN	15 kN	3
PGR1TT40J	15 kN	15 kN	15 kN	3

All trolleys and sheave carriers are rated for one user.



The following information is based on REID Lifting's recommendations and does not remove the responsibility of the user to comply with the relevant regulations and standards that are valid in the respective countries and regions where the system is being used.

Regular Inspections

To ensure that the product's frame remains in safe working order it must be inspected regularly by a competent or qualified person. We recommend inspections every 6 months for personnel lifting and every 12 months for goods only, unless local regulations, adverse working conditions or profile of use and risk dictate shorter periods. The components of the system need to be checked for damage, wear, corrosion or other irregularities. It may be necessary to disassemble the system in order to do this. Particular attention should be paid to checking the profiles for denting, pins and fixings for integrity, making sure there is no wear or elongation on the bolt holes and ensuring that the trolley moves freely along the beam.

It is recommended that once inspected or repaired, the device is marked with the date of the next inspection.

Inspections are instigated by the user. If detailed information is required on inspection and test criteria, please contact your supplier's technical department or REID Lifting. The equipment Inspection Record is on page 35.

If using the product in explosive atmospheres, see additional section titled ATEX.

Maintenance & Repair

In order to ensure correct operation, the conditions for inspection and maintenance must be complied with. If any defects are found, stop using the product immediately.

No alterations or additions to the equipment beyond the replacement of standard parts by an authorised representative should be made without the written consent of the manufacturer. Any necessary repairs identified during inspections should only be carried out by an approved specialist workshop using original spare parts. Any repair must be carried out in accordance with the manufacturer's instructions.

It is recommended to maintain the equipment in a clean and dry manner. Cleaning is suggested using a sponge or cloth with warm, soapy water, rinsing and allowing to dry.

This product must be assembled using metric fixings of the same type and quality as those supplied by the original manufacturer only. Failure to do so could have an impact on the structural performance and stability of the product. REID Lifting and its resellers can supply these spare parts locally.

Storage & Transportation

When transporting the components, take note of all the manual handling considerations.

Do not throw the product down or stack any items on top of it.

Always place carefully and securely on the ground to avoid damaging the equipment.



ATEX

This product has been designed for use in explosive atmospheres in line with the following requirements and information. Any use which differs or exceeds this is considered incorrect and REID Lifting will not accept any responsibility or liability for damages resulting from false application. The risk is solely with the user. If the product has been customised in any way, then it may not comply with standards and no longer be suitable for use in explosive atmospheres. If this is the case, then the product will not have any of the markings below. In in doubt, please contact your REID representative.

Classification [Zone 2]

As standard, the product meets the requirements of Category 3 equipment for use in Zone 2 explosive atmospheres, providing a normal level of protection where mixtures of air and gases, vapours or mists or by air and dusts mixtures are unlikely to occur or, if they do occur, are likely to do so only infrequently and for a short period only.

The product will have the following identification on the serial label:

As Standard for Zone 2 Environments:

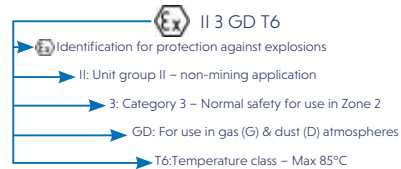

Classification [Zone 1]

Available as an upgrade, the product can be supplied to meet the requirements of Category 2 equipment for use in Zone 1 explosive atmospheres, providing a high level of protection where mixtures of air and gases, vapours, mists or by air and dusts mixtures are likely to occur.

The product will have the following identification on the serial label:

As an upgrade for use in Zone 1 environments:

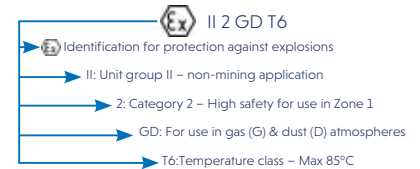

Spark Formation

There is an increased danger of ignition when certain material pairings clash, namely non-corrosion-resistant steel or cast iron against aluminium, magnesium or pertinent alloys. This applies especially in the case of rust or surface rust. When assembling the product and inserting fastening components, these must therefore be clear of rust and debris of any kind. As stated previously, care must be taken to ensure the gantry is handled in a suitable manner, never thrown down and always placed carefully onto the ground.

- › REID recommends the use of corrosion resistant tools when assembling this system to prevent the possibility of any sparks.
- › For ATEX Zone 1 use, stainless steel castor brackets are fitted to reduce the possibility of a spark.

Static Electricity

For Zone 2 applications, there is a potential risk of static electricity build-up leading to an incentive spark. Although the risk of such ignition is unlikely, the system must be earthed during assembly and use. This can be achieved by attaching an earthing lead to a convenient location on metallic parts of both the system and trolley.

For additional protection in Zone 1 applications, the system is fitted with anti-static trolley rollers, stainless steel fasteners and therefore does not need to be earthed.

However, the effectiveness of the conductivity during operation can be affected by a dirty tread or other environmental influences and therefore must be checked periodically by the operator.

Inspection, Maintenance & Repair

Special attention should be given to dust deposits on the structure, especially in areas where the profiles come into contact, and should be wiped clean and care taken not to apply materials that could create electrostatic charging. Additionally, the bearings in the trolley rollers and castors should be checked to ensure they rotate freely.

The structure is predominantly constructed from aluminium which will not rust. However, there are steel components used throughout. These are; fasteners, castors, master-link, trolley rollers, A-frame height adjustment gearing system (if fitted) and the height adjustment ratchet (if fitted).

Where there is sign of any rust deposits on the aluminum structure, it should be wiped clean as above and, where there is sign of rust on a steel component, that component should be removed from use and the structure not used until a replacement is fitted.

If using the product in explosive atmospheres, in addition to the Regular Inspection and Maintenance information above, these additional instructions should be followed:

- › Inspections must be instigated by the user prior to each use if used in a potentially explosive atmosphere.
- › Inspections and maintenance must be carried out at a safe distance away from an explosive atmosphere.

► Assembly Instructions

The PORTA GANTRY RAPIDE and its constituent components are described in the image below.

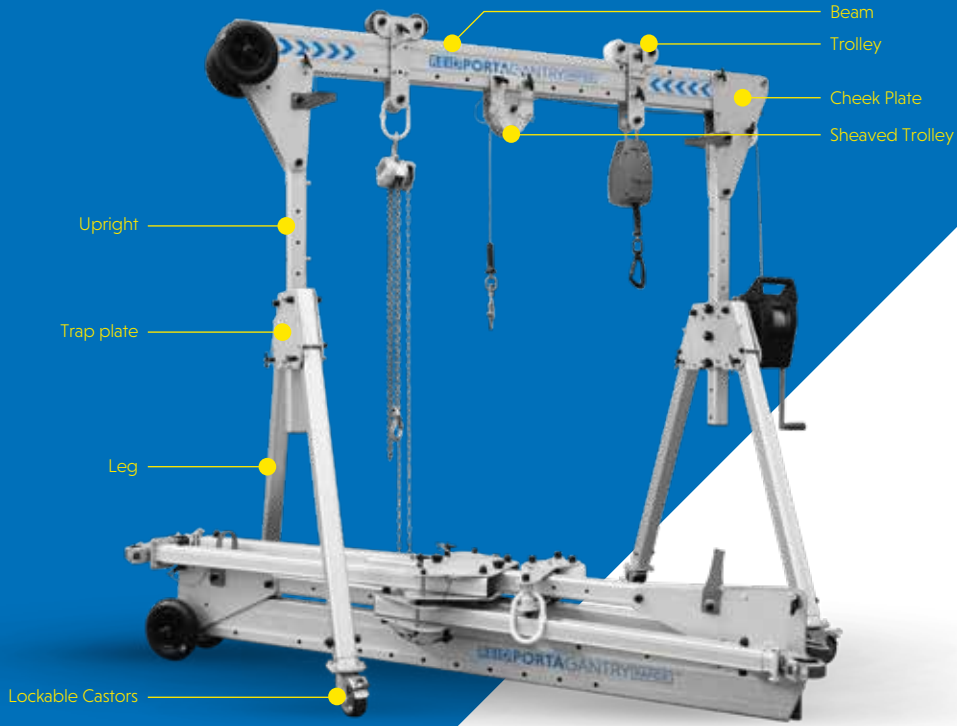

Appropriate PPE should be worn: ► Gloves ► Protective Footwear ► Hard Hat



Pre-Assembly

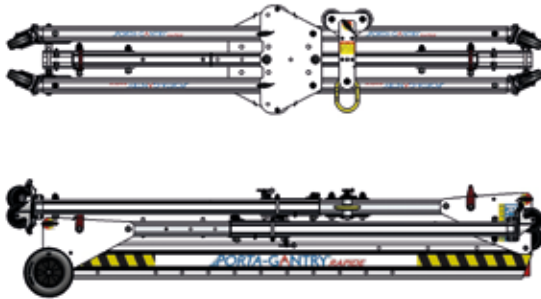

Pre set-up checks

- > This product is delivered flat packed
- > Ensure the castors are locked
- > Allow sufficient clearance for the A-Frame rotation. If sufficient space not available see steps 13 to 17 - Confined Space set-up method

N.B. Trolley can be stored separately, on the upper A-Frame or the Leg.

Standard Assembly



Rotate upper A-Frame to a vertical position.

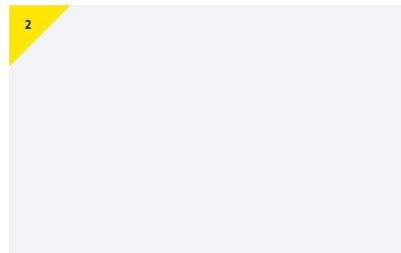

While in this vertical position remove ball lock pin from its stow hole on the Trap Plate.



Open leg and insert ball-lock pin into second hole securing the leg in its open position. Repeat for second leg on the same A-Frame.



- › Continue the rotation of the A-Frame until it comes to rest on ground



- › Repeat steps 1-4 for lower A-Frame



Be careful not to trap hands between beam and cheek plates!

- › Scissor upper A-Frame until ball-lock pin is adjacent to beam
- › Remove ball-lock pin and continue scissor motion until stops engage beam and holes are aligned



- › Re-insert ball-lock pin into hole ensuring the pin is fully engaged through hole. A gentle rocking motion can be used to induce alignment

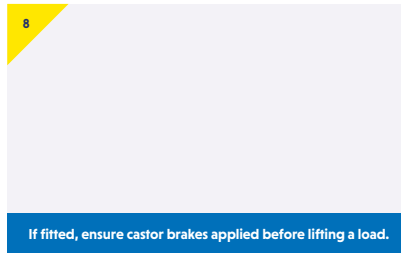

If fitted, ensure castor brakes applied before lifting a load.

- › Repeat steps 6 and 7 for opposite A-Frame

Master-link / Close-Coupled Trolley Installation

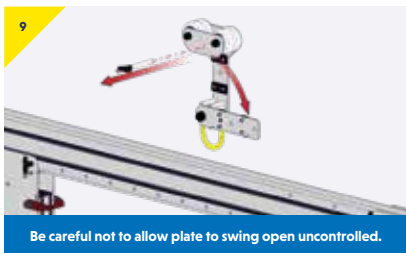

- Remove pin
- Open trolley and present to beam with plate rotated through 90°

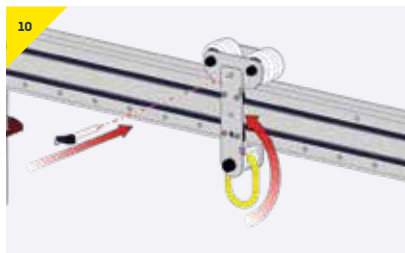

- Close trolley plate encapsulating the beam and re-insert ball-lock pin
- Ensure pin is properly engaged through holes
- If trolleys are required to be locked into position then an additional pin is available to provide trolley lock-off

Foot Adjustment



- To increase height pull foot down until desired position is achieved

Height Adjustment

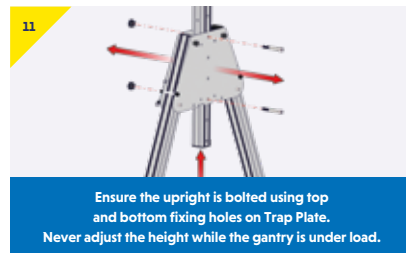

- Take weight of gantry upright
- Remove bolts and adjust to the desired height
- Re-insert bolts and hand tighten quick release knobs ensuring the gantry is secure

Pre-lift checks

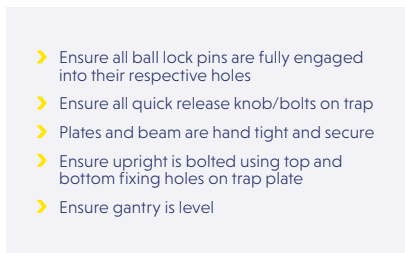

- Ensure all ball lock pins are fully engaged into their respective holes
- Ensure all quick release knob/bolts on trap
- Plates and beam are hand tight and secure
- Ensure upright is bolted using top and bottom fixing holes on trap plate
- Ensure gantry is level



Confined Space Assembly



- › Rotate upper A-Frame to vertical position

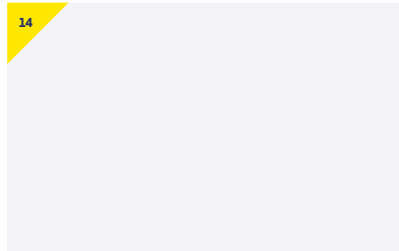

- › While in this vertical position remove ball lock pin from its stow hole



- › Open leg and insert ball-lock pin into second hole securing the leg in its open position.
- › Repeat for second leg



Be careful not to trap hands between beam and cheek plates!

- › Rotate upper A-Frame around until ball-lock pin is adjacent to beam
- › Remove pin and continue motion, follow steps 6 and 7

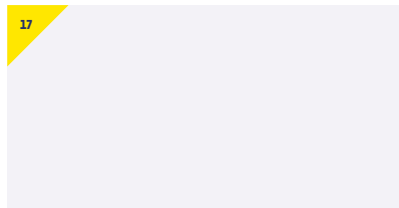

If fitted, ensure castor brakes applied before lifting a load.

- › Repeat steps 13 to 16 for lower A-Frame

Pre-lift checks

- › Ensure all ball lock pins are fully engaged into their respective holes
- › Ensure all quick release knob/bolts on trap plates and beam are hand tight and secure
- › Ensure upright is bolted using top and bottom fixing holes on trap plate
- › Ensure gantry is level

Gantry Stowage

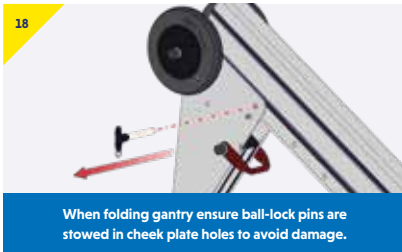

- To fold the gantry reverse steps 10 to 1 for Standard Assembly or steps 17 to 13 for Confined Space Assembly

Trolley Storing



- Trolley can be stored separately, on the upper A-Frame or the leg

Winch Bracket Installation

Never install winch bracket while gantry is under load. Only install winches which are approved by REID for use with the PORTA GANTRY RAPIDE and a suitable interface / mounting plate supplied.

Winch can be installed on both sides of gantry and on either bolts A and B or B and C (PGR250-500) OR A and B, B and C or A and D (PGR1000). Ensure winch bracket and quick release knobs are hand tight.

PGR250-500

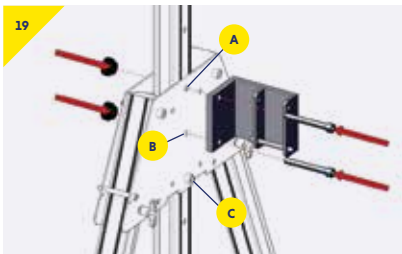

- Remove existing bolt, A or C
- Present bracket to gantry as shown (with locating pin at bottom) and insert new, longer bolts securing the winch with the quick release knobs provided

PGR1000

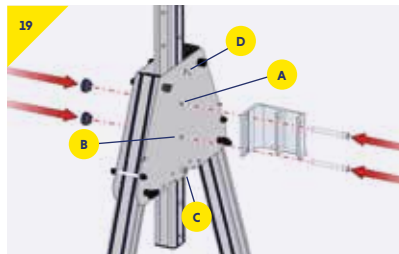



Winch Installation

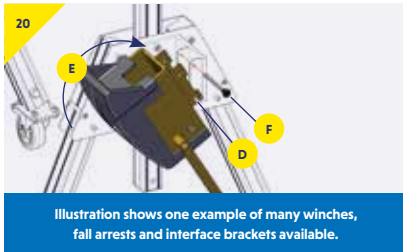

- Place winch onto locating pin, D
- Rotate winch to align holes, E

20a

- Place retaining pin into holes, F
- Observe pin is securely engaged

Fall Arrest Block Installation



- Present the fall arrest block to the Upright as shown and ensure it is aligned with the holes

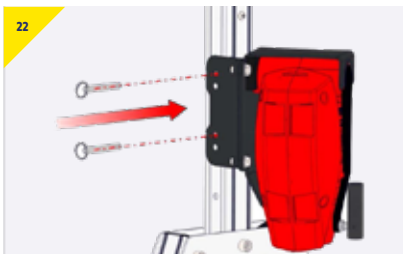

- Insert the retaining pins to secure in place on the Upright

Sheave Trolley Installation

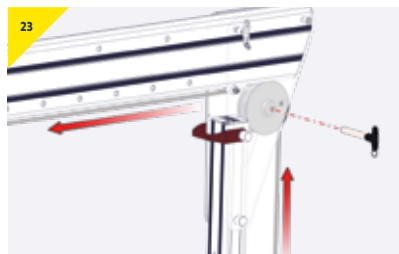

- Thread rope through cheek plates and capture rope between sheave and beam
- Secure sheave with ball-lock pin
- Observe pin is securely engaged



- Present sheaved trolley to underside of beam
- Capture rope between sheaved trolley and beam and insert pin as shown

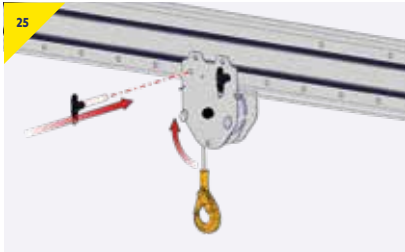

- Insert second pin as shown
- Observe both pins are fully engaged

Beam Width Adjustment

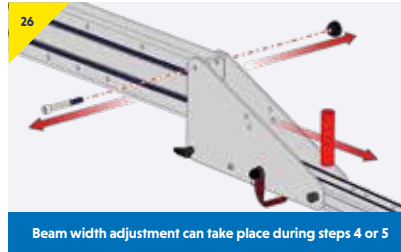

Beam width adjustment can take place during steps 4 or 5

- Remove bolt and handle
- Store handle in safe place

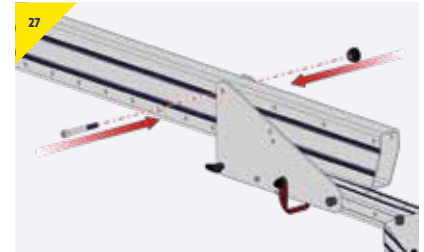

- Move A-Frame assembly to required position
- Re-insert bolt and hand tighten quick release knob
- Complete assembly of gantry as steps 6-8

Changing the Foot Option



- The foot option can be changed by removing the ball lock pin and withdrawing the foot cartridge assembly

Adjustable Foot Option



- For coarse adjustment in leg height set cartridge at desired point (2x50mm increments)



Never adjust the height while the gantry is under load.

- For fine height adjustment depress lever and push foot up to desired position
- Observe gantry is level



PORTAGANTRY **RAPIDE**™ 250-500

- A** Beam length
- B** Beam adjustment
- C** Clear operating span
- D** Height to lifting eye
- E** Height increment
- F** Height to top of beam
- G** Width
- H** Height to top of roller
- J** Length

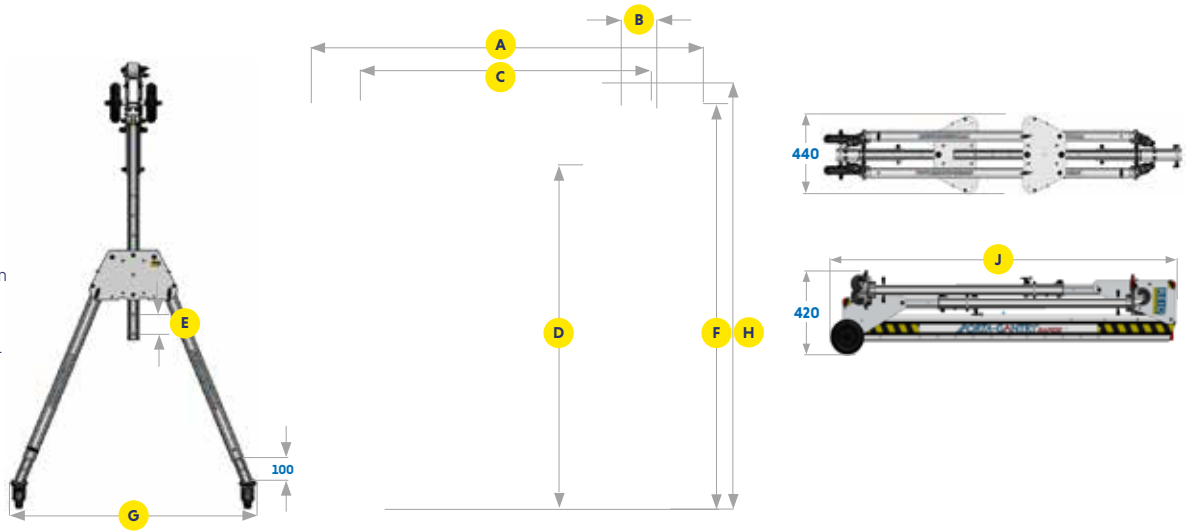

	Dimensions [mm]												WLL			Unit Weight***	
	A Beam Length	B	CMin	CMax	DMin	DMax	E	FMin	FMax	G	HMin	HMax	J	Goods Capacity [kg]	Fall Arrest Capacity** No of Person(s)	Personnel Positioning** [kg]	[kg]
PGRS20	2000	2 x 200	1100	1500	1450	2050	6 x 100	1776	2376	1158	1856	2456	2080	500	3	250	37
PGRS23	2300	3 x 200	1200	1800									2380	400	2	200	38
PGRS40	4000	3 x 200	2900	3500									4080	250	1	125	43
PGRM20	2000	2 x 200	1100	1500	1454	2154	7 x 100	1780	2480	1215	1860	2560	2080	400	2	200	38
PGRM23	2300	3 x 200	1200	1800									2380				38
PGRM40	4000	3 x 200	2900	3500									4080	44			
PGRT20*	2000	2 x 200	665	1065	1928	2928	10 x 100	2254	3254	1586	2334	3334	2645	250	1	125	42
PGRT23*	2300	3 x 200	765	1365									2380				43
PGRT40*	4000	3 x 200	2465	3065									4080				48

*Trolley stops fitted to beam **Ratings using European standards. Contact REID for other standards. *** Weight includes castor inserts.



PORTAGANTRY **RAPIDE**™ 1000

- A** Beam length
- B** Beam adjustment
- C** Clear operating span
- D** Height to lifting eye
- E** Height increment
- F** Height to top of beam
- G** Width
- H** Height to top of roller
- J** Folded dimensions

